



**TECHNICAL
SPECIFICATIONS
(SMTS) - Clients
Rainscreen System**



MITREX™

BUILDING-INTEGRATED SOLAR TECHNOLOGY

STANDARD MITREX TECHNICAL SPECIFICATIONS (SMTS)

1. TERMS AND DEFINITIONS

For the purpose of this document the terms and definitions given in SMTS (Standard Mitrex Technical Specification) and the following apply.

1.1 Panel for cladding.

Panel cut to size which forms a wall and ceiling finishes for outside or inside use, fixed to a structure mechanically.

1.2 Dimensions of panels for cladding.

The length l , width b and thickness d are the dimensions of a panel for cladding. They are given in the stated sequence in inches (see Figure 1).

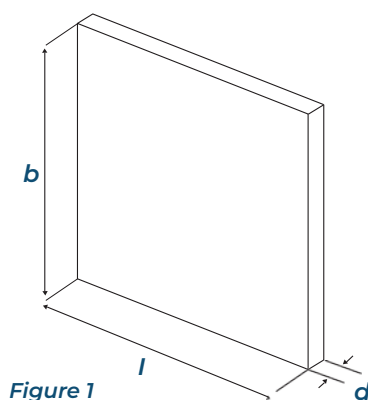

2. REQUIREMENTS

2.1 Requirements for geometric characteristics

2.1.1 General.

All measurements shall be carried out in accordance with SMTS and all measured values of individual units shall fall within the required tolerances.

2.1.2 Requirements for thickness by more than given in Table 1.

Table 1 – Tolerances on the nominal thickness

NOMINAL THICKNESS IN INCHES	TOLERANCE
More than 1/2" up to and including 2"	$\pm 1/8"$
More than 2" up to and including 5"	$\pm 1/4"$
More than 5"	$\pm 1/2"$

The required thickness of panels shall result from a structural analysis or similar procedure which takes into account the technical and physical properties of the panel and the intended application.

STANDARD MITREX TECHNICAL SPECIFICATIONS (SMTS)

2.1.3 Requirements for flatness.

The deviation from flatness of the surface shall not exceed 0.2" % of the panel length and shall not exceed 1-1/2". For natural cleft faces, the tolerance on flatness shall be declared by manufacturer.

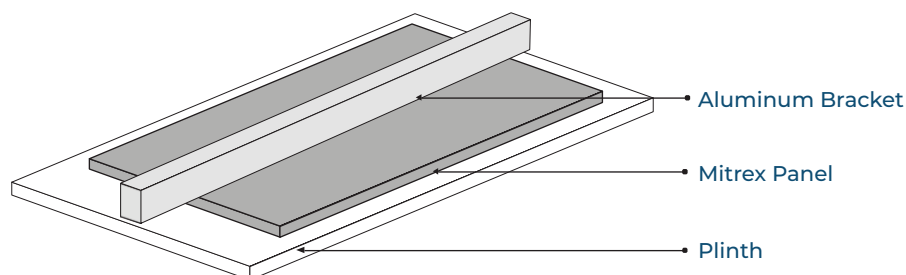

	TRANSVERSAL		LONGITUDINAL	
Thickness	Width	F	Length	F
1"	60"	≤ 1/4"	Length	≤ 1/4"

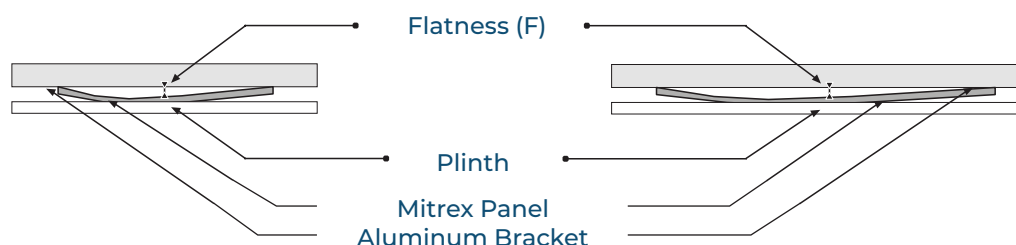

2.1.4 Requirements for length and width.

The length or width shall not deviate from the nominal size by more than given in.

Table 2 – Tolerances on length and width

NOMINAL LENGTH OR WIDTH IN INCH	< 24"	≥ 24"
Sawn edges thickness	± 1/16"	± 1/8"

2.1.5 Requirements for angles and special shapes

The permissible tolerance at any point shall be as stated in Table 2.

Each panel angle shall be in accordance with the agreed geometry. Pieces of special or irregular shape shall be checked for compliance with the required shape by use of a suitable template, the permissible tolerance at any point shall be as stated in Table 2.

STANDARD MITREX TECHNICAL SPECIFICATIONS (SMTS)

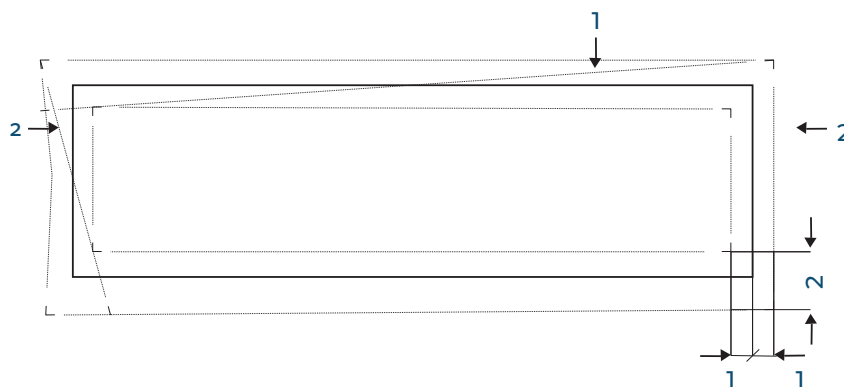

Figure 2 - Example of tolerances on angles.

1. Nominal size.
2. The slab sides shall fall within the two dotted lines indicating the tolerance of length and width according to table 2. Max. angle tolerance is $\pm 0.5\%$.

2.1.6 Requirements for surface finish

2.1.6.1 General.

Surface finishes shall be carried out uniformly to the edges of the cladding panel.

The surface finishing of some panels may typically involve the use of patching, fillers or other similar products; this is to be considered as part of the normal processing. In such cases the type of treatment, as well as the type and nature of additional materials, shall be declared.

Requirements for surfaces after surface finishing.

Surfaces shall have a regular appearance as a function of the finishing process and shall be worked to meet the specified finish (e.g. making reference to samples) on all exposed surfaces.

Mitrex panels are subject to variation in color, shading, veining, and patching.

NOTE 1: Surfaces obtained by grinding are, for example:

- Rough ground surfaces obtained, e.g. by means of a grinding disk of grain size F60 (Acid wash);
- Medium ground surfaces obtained, e.g. by means of a grinding disk of grain size F120;
- Fine ground surfaces obtained, e.g. by means of a grinding disk of grain size F220;
- Matt finished surfaces obtained, e.g. by means of a grinding disk with grain size F400;
- Highly polished surfaces obtained, e.g. by means of a polishing disk or felt F600.

NOTE 2: Surfaces obtained by means of percussion tools are as per sample:

2.2 General

This characteristic shall always be declared.

The colour, veining, texture, etc. of the Material shall be identified visually, typically by a reference sample of the same pattern suitable for providing a general description of visual appearance. The reference sample shall be provided by the supplier.

STANDARD MITREX TECHNICAL SPECIFICATIONS (SMTS)

2.3 Reference sample, visual inspection and acceptance and acceptance criteria.

A reference sample shall be an adequate number of pieces of sufficient size to indicate the general appearance of the finished work. The dimensions of individual pieces shall be at least 0,01 square meters (typical values are between 0,01 and 0,25 square meters in face area but may be more) and shall indicate the range of appearance regarding the colouring, the vein pattern, the physical structure and the surface finish.

The reference sample does not imply strict uniformity between the sample itself and the actual supply; variations may always occur.

All the characteristics as shown by the reference sample shall be considered typical of the panel and not as flaws, therefore they shall not become a reason for rejection, unless their concentration becomes excessive and the typical character of the panel is lost.

Any comparison between production sample and reference sample shall be carried out by placing the reference sample against the production samples and viewing them at a distance of about two meters under normal daylight conditions and recording any visible differences in the characteristics of the panels (Figure 3).

2.4 Damage to walls caused by movement of panel and footing and other causes.

2.5 Inspection surfaces from a normal viewing position.

Generally, variations in the surface colour, texture and finish of walls, ceilings, floors and roofs, and variation to be viewed where possible from a normal viewing position. A normal viewing position is looking at a distance minimum 2 meters with the surface or material being illuminated by “non-critical light” means the light that strikes the surface is diffused and is not glancing or parallel to that surface.

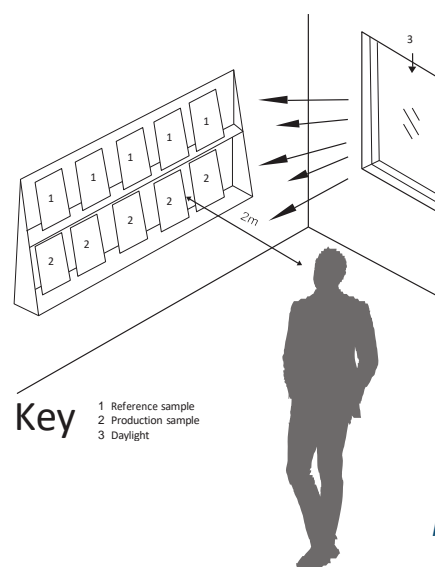

Figure 3

DESCRIPTION OF TYPICAL DAMAGE AND REQUIRED REPAIR	CRACK WIDTH LIMIT	CRACK CATEGORY
Hairline Cracks	< 0.1mm	0
Fine cracks that do not need repair.	1/16"	1
Cracks noticeable but easily filled.	<1/4"	2
Cracks can be repaired and possibly a small amount of wall will need to be replaced.	1/4 - 3/4" (or a number of cracks 0.12 or more in one group)	3
Extensive repair work involving breaking-out and replacing sections but also depends of walls.	3/4 - " but also depends on number of cracks.	4

STANDARD MITREX TECHNICAL SPECIFICATIONS (SMTS)

2.6 The measurement of SMTS tolerances

Vertical Surfaces

Deviations of vertical surface from a true vertical plane are to be measured from a plumb line through a plan position or reference point nominated in the contract documents or

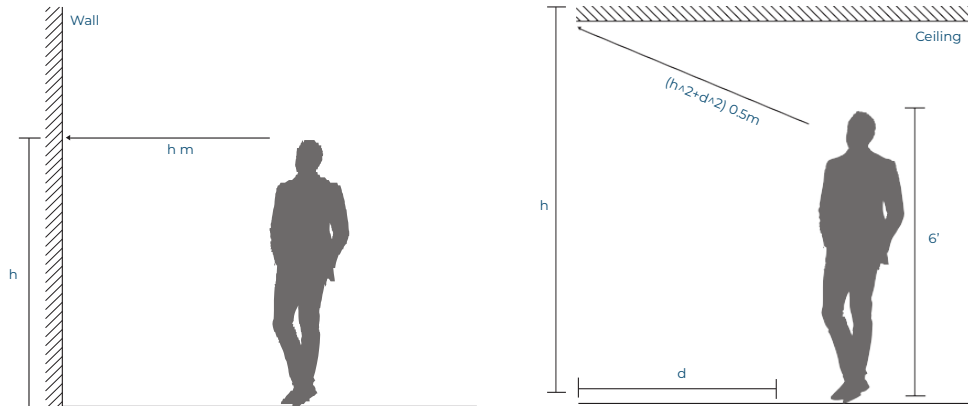

inferred if none is nominated. The maximum deviation of a vertical surface from that plumb line will not exceed more than 1/2" from a plane surface (Bow) in any 2 m length. Refer to below diagrams. Where diagrams are provided for the clarification of details, the diagram shows only detail relevant to the issue and is not intended to be used as general details for construction.

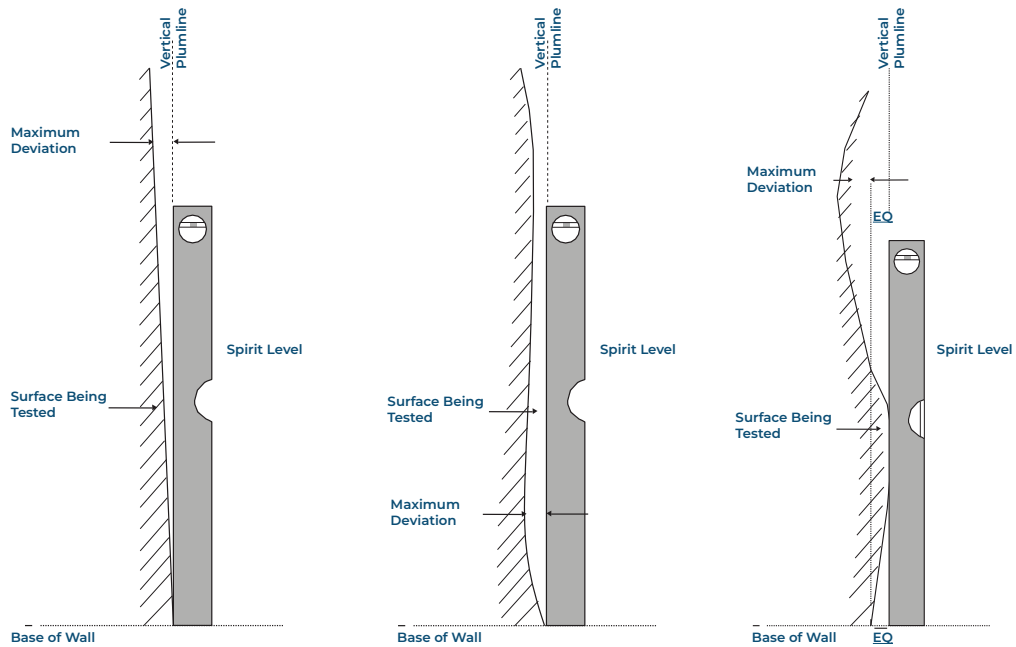

STANDARD MITREX TECHNICAL SPECIFICATIONS (SMTS)

2.7 Tolerance in Mitrex Panel installation

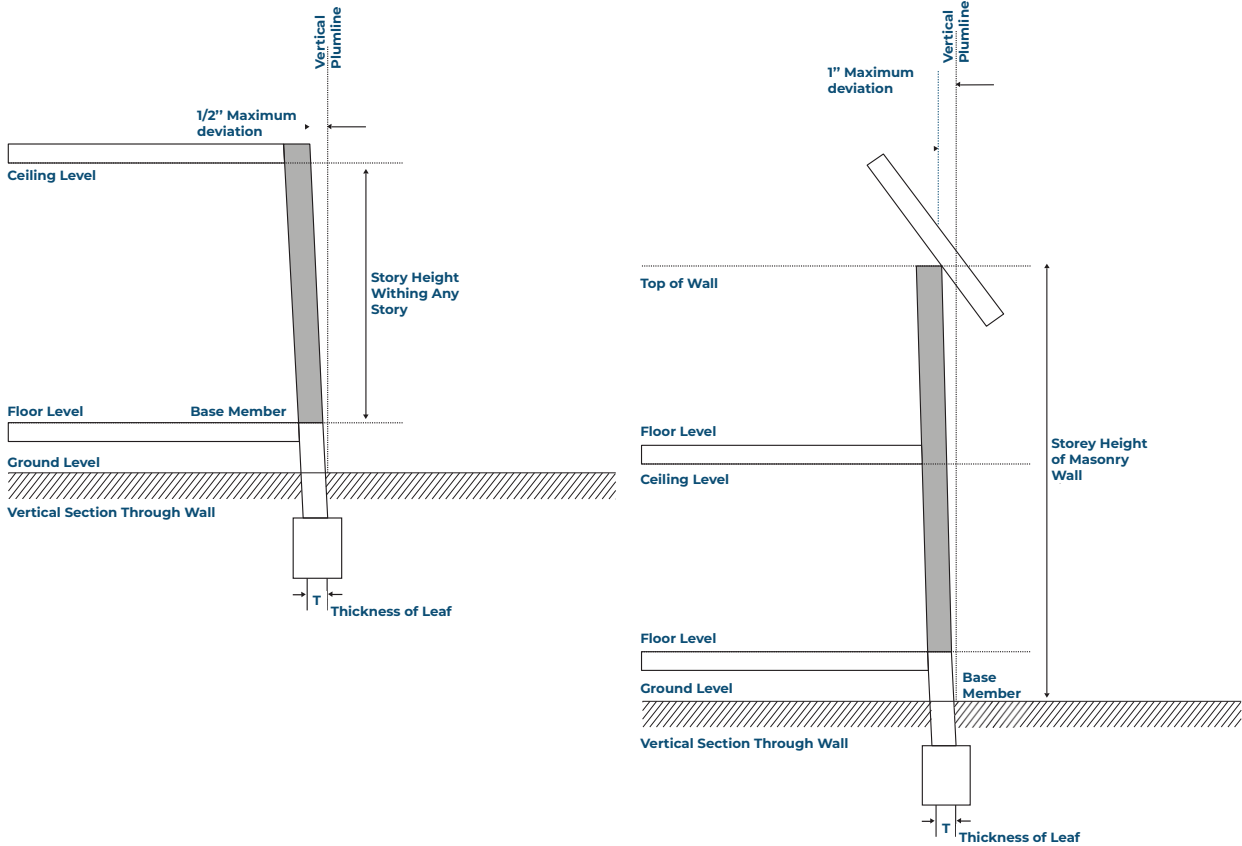

2.8 Tolerances in installation of Mitrex panels.

For width of panel 1500 mm: $\pm 1/4"$ - 0,1%

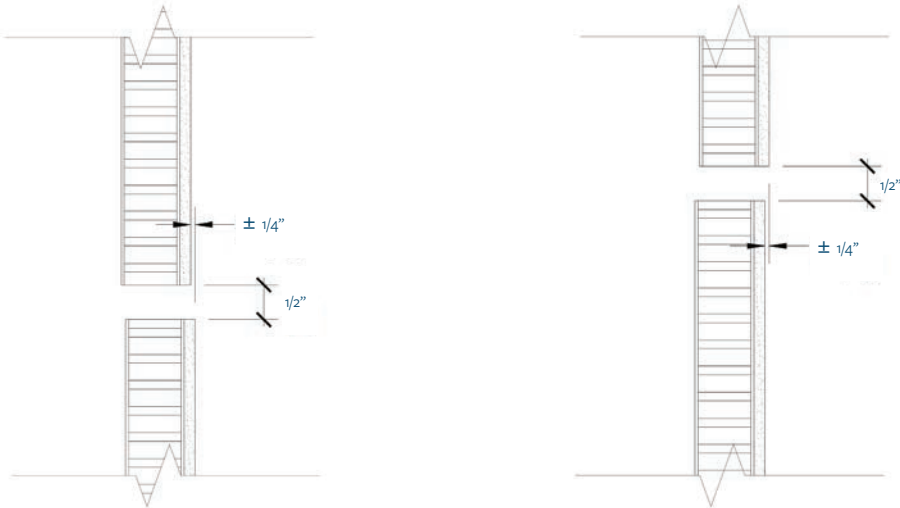

STANDARD MITREX TECHNICAL SPECIFICATIONS (SMTS)

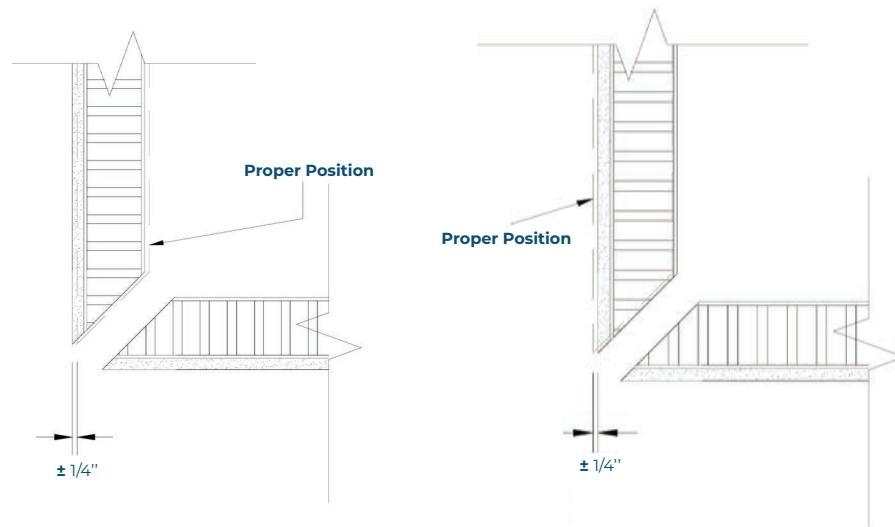

2.9 Tolerances in installation of Mitrex panels- Joint Tolerances.

Acceptable panel to panel: all ceiling and floor joint gaps.

DESCRIPTION OF THE JOINT CONDITION	Joint Size	
	MIN	MAX
Panel to Panel	1/8"	1/2"
Panel to Wall	0"	1" - 3/4"
Panel to Ceiling	0"	1" - 3/4"
Panel to Floor	0"	1" - 3/4"

Note: Site conditions and wall conditions may affect the acceptable tolerances. The Min and Max acceptable tolerances are calculated based on the highest point on the outages.

2.10 Tolerances in installation of Mitrex panels - Panel joints

For panel alignment: Ins and outs - Max $\pm 1/4"$

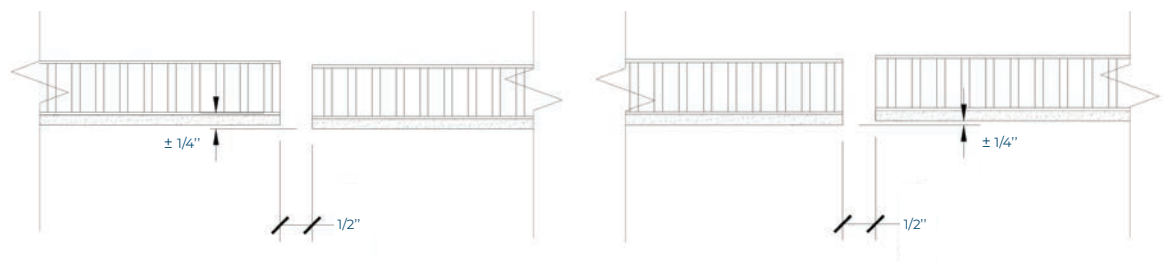

STANDARD MITREX TECHNICAL SPECIFICATIONS (SMTS)

2.11 Tolerances in installation of Mitrex panels- Horizontal and Vertical joints.

For panel alignment: Horizontal joint to Vertical joint - Max $\pm 1/4"$

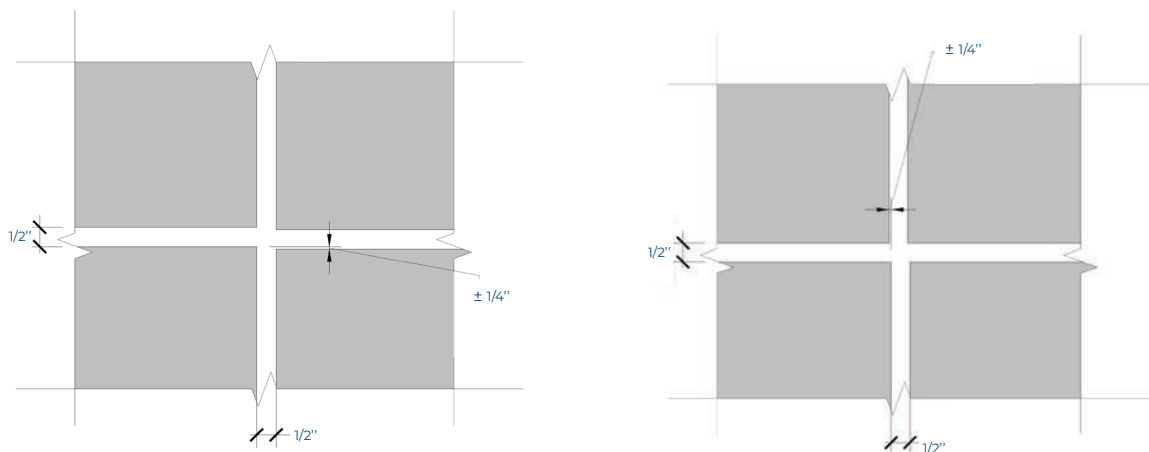

2.12 Tolerances in installation of Mitrex panels- Joint consistency

For the joint between the panel at 1500 mm and more: $\pm 1/4"$

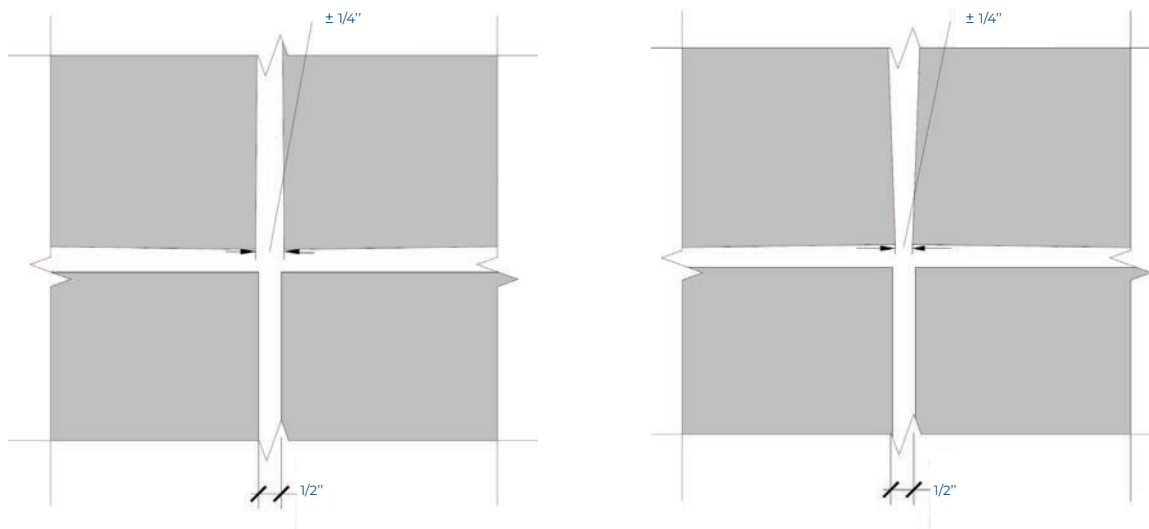



 **MITREX**TM
BUILDING INTEGRATED SOLAR TECHNOLOGY

 mitrex.com

 info@mitrex.com

 +1 (855) 254 0214 (Toll Free)

Headquarters:

 41 Racine Rd., Toronto,
ON M9W 2Z4, Canada

 +1 (416) 497 7120

West USA Location:

 10880 Wilshire Blvd Suite 1101,
Los Angeles, CA 90024, USA

 +1 (323) 301 7978

East USA Location:

 1 Rockefeller Plaza Fl 10 & 11,
New York, NY 10020, USA

 +1 (646) 583 4486